

Article number: 2310313945

Description: E+G Levelling element
LV.F-125-ACV-M30x186

Measures

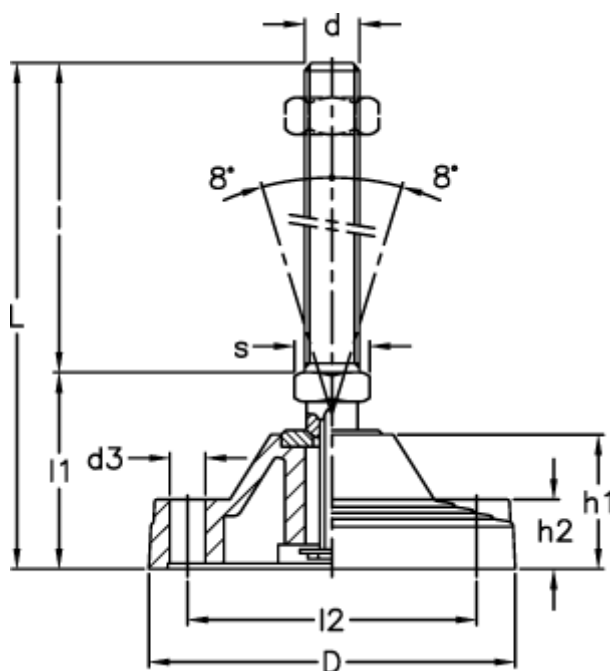

D = 125	I2 = 95
d = M30	Max load (N) = 40000
d3 = 12.5	s = 30
h1 = 45	
h2 = 23	
l = 186	
L = 250	
l1 = 64	